



AGArangeusa.com

39" CLASSIC DUAL CONTROL (ELECTRIC/GAS)

MODEL: **ADC3G**
MSRP: **\$21,849**



The AGA Classic 39" Dual Control is everything you love about the AGA range cooker, but with added flexibility and reduced running and servicing costs. Available as an electric or gas model, this range offers the ability to operate the hotplates independently from the ovens with a simple turn of a dial.

OVERVIEW

The AGA Classic 39" Dual Control features three large-capacity, natural gas fueled cast-iron ovens: a roasting oven, a baking oven, and a simmering oven. The two electric cast-iron hotplates feature one for boiling and another for simmering—both able to accommodate extra-large pans and also perfect as a griddle cooking surface.

The ovens are heated by a single heat source to bring the solid cast iron up to full temperature in 8 hours or in just 4 hours from standby mode. The cast-iron ovens cook using radiant heat, meaning all the flavor, moisture, and goodness is locked into every dish. The electric hotplates are independently controlled, can be switched on and off as needed, and can heat up in 10 to 12 minutes.

The AGA Classic 39" Dual Control is available in 17 contemporary colors along with a stainless steel trim package.

SPECIFICATIONS

- Product Dimensions: 35⁷/₈" H x 38⁷/₈" W x 27¹/₂" D
- Shipping weight (lbs): 1135 lbs (includes range, crate & pallet)

WARRANTY

- 5 Year Limited Warranty on all parts and labor

FINISHES

- The AGA Classic is coated in hygienic, easy-to-clean vitreous enamel (Due to the custom nature of this product, please allow a minimum of 110 to 140 days lead time from receipt of order)

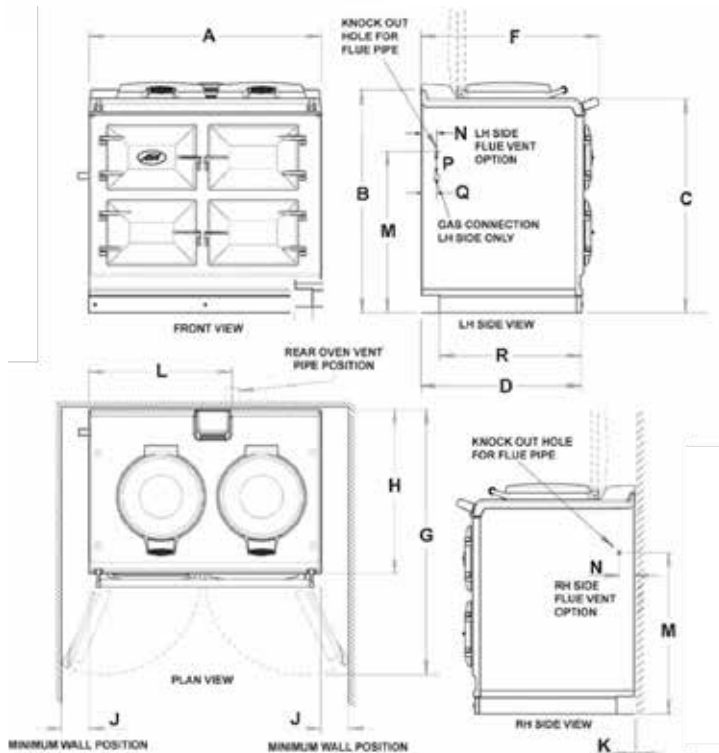

	A	B	C	D	E	F	G	H	J	K	L	M	N	p	Q	R
mm	987	948	910	680	1388	756	1145	698	116	10	565	689	43	118	55	634
ins	38 ⁷ / ₈	37 ¹ / ₈	35 ³ / ₈	26 ³ / ₈	54 ¹ / ₂	29 ³ / ₈	45 ¹ / ₂	27 ¹ / ₂	4 ⁵ / ₈	1/8	22 ¹ / ₄	27 ¹ / ₄	1 ³ / ₄	4 ⁵ / ₈	2 ¹ / ₄	25





AGArangeusa.com

39" CLASSIC TOTAL CONTROL RANGE



FEATURES

- Cast Iron Ovens use Natural Gas and the Hotplates use Electric
- Cast iron radiant heat cooking throughout each oven and both hotplates providing 10 Cooking Methods in one range
- Three Large Capacity Multi-Function Cast Iron Ovens:
 - Roasting oven (approx. 425°F-475°F)
 - Baking oven (approx. 325°F-375°F)
 - Slow Cook oven (approx. 212°F-245°F)
- Two 14½" diameter Cast Iron Hotplates – Boiling hotplate (626°F) and Simmering hotplate (392°F) can accommodate extra-large pans or may be used as a griddle cooking surface
- The ovens are heated by a single Heat Source giving gradual radiant heat to bring solid cast iron up to temperature
- Ovens will heat to full temperature in 8 hours from cold or 4 hours from Slumber; Hotplates take under 11 minutes to reach full temperature
- Hotplates operate independent from the ovens and separate from each other
- External fan assisted power venting

Complimentary Cookware Included:

- (1) 13" x 18" Large Enameled Roasting Pan with Broiling Rack
- (1) 12 ½" x 13 ½" Half Size Enameled Roasting Pan with Broiling Rack
- (1) 18 ¾" x 13 ½" Floor Grid
- (3) 17" x 13 ½" Oven Grid Shelves
- (1) Cold Plain Shelf
- (1) Hotplate Toaster
- (1) Wire Brush

CAST IRON BENEFITS

Acclaimed as one of the most perfect mediums for great cooking because it retains heat well, has even heat distribution and radiates a gentle heat aiding food in flavor retention and succulence.

Cast iron cooking means ease of cleaning because oven splashes and spills are carbonized and simply require wiping out. An AGA also means fewer intrusive cooking smells.

A large proportion of each cast iron AGA has been made from recycled material, and is almost completely recyclable.

INSULATED COVERS

The distinctive hallmark of the AGA, the highly polished stainless steel insulated covers are brought down over the hotplates to help contain the heat when on and protect the hotplate when off.

Specifications are subject to change without notice. Visit agarangeusa.com for the most up-to-date information.



AGArangeusa.com

39" CLASSIC DUAL CONTROL (ELECTRIC/GAS)

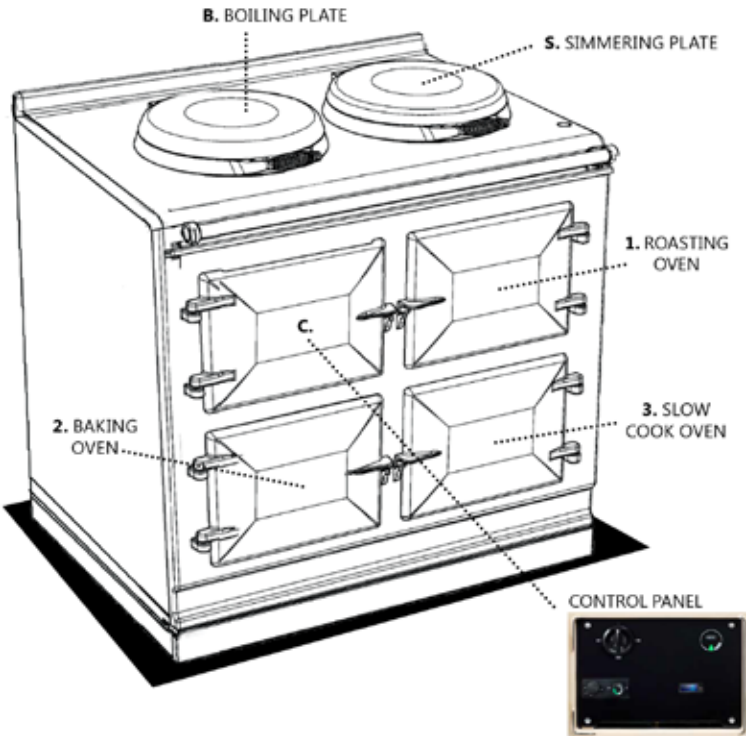

INSTALLATION

Range Dimensions

When surveying for range installation the actual clearance required for the 'body' of the appliance should be increased by $\frac{3}{8}$ " beyond the figures quote above. This allows safe margin to take into account the natural dimensional variations found in major castings. In particular the width across the appliance recess could be critical.

Range Base or Hearth

It is essential that the base or hearth on which the range stands should be level. The base of the built-in AGA plinth must be level and sit above finished floor height for service access. The front plinth cover is removable and must not be obstructed by flooring or tiles. If necessary the range must be raised by the thickness of the tiles to ensure the plinth can be removed.

Minimum Clearance to Combustibles

A gap of at least $\frac{1}{2}$ " must be observed between the rear of the top plate, and the wall behind the appliance. If the rear wall is of combustible material there must be a gap of 1".

Clearances

A $\frac{1}{8}$ " gap is required each side between the range top plate and adjoining work surfaces that may be fitted, this is to allow for the safe removal of the top plate should this be required at a later date. Where ranges are fitted against side walls a $\frac{49}{16}$ " side clearance is required on the right and left hand side for oven doors access. If the AGA is to be installed in a brick recess, then the minimum clearance should be increased by at least $\frac{3}{8}$ ", to allow for the walls not being square. In addition a minimum clearance of $39\frac{1}{2}$ " must be available at the front of the range to enable it to be serviced.

Range Hoods

It is recommended this AGA is fitted with a range hood. The AGA venting system is located on top of the AGA between the two hotplates, and is designed for venting the moisture from the ovens. The range hood should be positioned not less than the minimum height as recommended by the manufacturer, from the top of the AGA.

Technical Specifications

Overall Dimensions	35 $\frac{1}{8}$ "H x 38 $\frac{3}{8}$ "W x 27 $\frac{1}{2}$ "D
1. Roasting Oven	9 $\frac{1}{4}$ "H x 13 $\frac{3}{8}$ "W x 18 $\frac{1}{4}$ "D
2. Baking Oven	9 $\frac{1}{4}$ "H x 13 $\frac{3}{8}$ "W x 18 $\frac{1}{4}$ "D
3. Slow Cook Oven	9 $\frac{1}{4}$ "H x 13 $\frac{3}{8}$ "W x 18 $\frac{1}{4}$ "D
B. Boiling Plate	14 $\frac{1}{2}$ " Dia
S. Simmering Plate	14 $\frac{1}{2}$ " Dia
C. Control Panel	9 $\frac{1}{4}$ "H x 13 $\frac{3}{8}$ "W
Weight	816 lbs
Shipping Weight	1135 lbs
Electrical Requirements	240v, 40amp, 60Hz
Fuel/Power	Natural Gas Ovens, Electric Hotplates
Vent Options	External venting flue
Warranty	5 Year Limited Warranty 1 Year Labor
Shipping Instruction	Ships fully assembled



AGArangeusa.com

39" CLASSIC DUAL CONTROL (ELECTRIC/GAS)

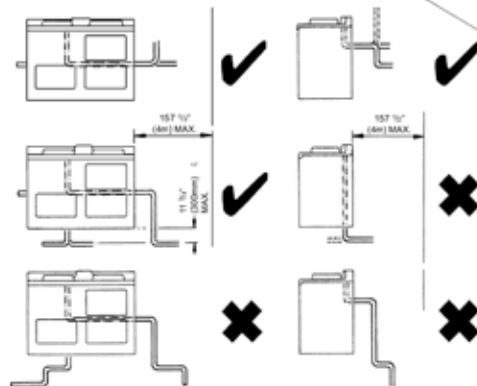
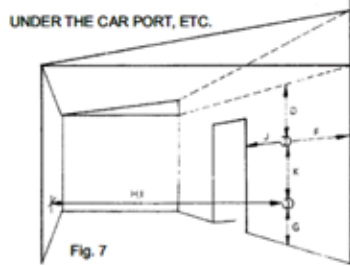
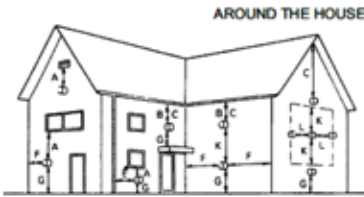
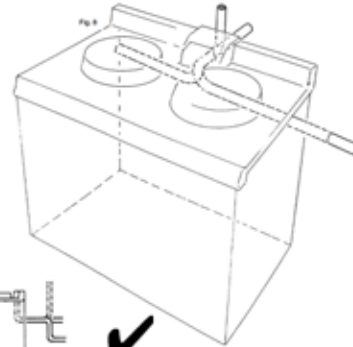
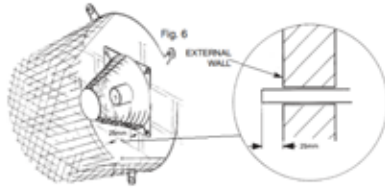

DOWNWARD RUNS UP TO 11 1/4" (300mm) BELOW THE APPLIANCE ARE ALLOWED, PROVIDED ONLY ONE BEND IS USED.
DOWNWARD RUNS USING 2 BENDS ARE NOT ALLOWED.

Fig. 9

NATURAL GAS	
MAXIMUM HEAT INPUT	6,800 Btu/hr
Thermostat Bypass	70
Main Burner Injector	112
Gas Supervision Injector	4212
Inlet Pressure	8" w.g.
Burner Pressure	4" w.g.

EXTERNAL VENTING

Flue System

The flue system must be installed in accordance with the federal, state and local codes. Products of combustion discharge is by a fan powered flue pipe of 2" diameter which can reach up to 13' in length through a maximum of 4 x 90° bend. Exits from the appliance can be from rear, LH or RH sides. (See Figs. 8 and 9). The flue pipe should protrude through the outside wall fixing plate by 1" (See Fig. 6).

Terminal Position

The minimum acceptable spacings from the terminal to obstructions and ventilation openings are as shown in Fig. 7. Where the terminal is fitted within 23 5/8" below plastic guttering an aluminium shield 39 3/8" long should be fitted to the underside and immediately beneath the guttering or eaves. Where the terminal is fitted within 17 3/4" below eaves or painted guttering an aluminium shield 29 1/2" long should be fitted to the underside and immediately beneath the guttering or eaves.

Terminal Protection

A terminal guard is supplied with the range and must be fitted, if flue termination is less than 78 3/4" above ground level, or subject to damage. When fitted, it must be positioned to provide a minimum of 2" clearance from any part of the terminal and be central over the terminal.

Position Spacing	Minimum inch (mm)
A Directly below an openable window, air vent, or any other ventilation opening	11 1/4" (300)
B Below gutter, drain/soil pipe	3" (75)
C Below eaves	7 3/8" (200)
D Below a balcony or car port roof	7 3/8" (200)
E From vertical drain pipes and soil pipes	5 3/8" (150)
F From internal or external corners	11 1/4" (300)
G Above adjacent ground or balcony level	11 1/4" (300)
H From surface facing the terminal	23 5/8" (600)
I Facing terminals	47 1/4" (1200)
J From opening (door/window) in car port into dwelling	47 1/4" (1200)
K Vertical from a terminal	59" (1500)
A Horizontally from a terminal	11 1/4" (300)